

universo
le porte
con rivestimento
tecnico di



COOPLEGNO

l'universo ti apre le sue porte



l'azienda

Oltre 50 anni di esperienza, una consolidata posizione nel mercato, la fiducia conquistata presso gli operatori del settore, tutto questo è CoopLegno, un'azienda che, partendo da un tessuto artigiano, ha saputo creare una solida realtà industriale capace di raccogliere consensi anche a livello internazionale.



il prodotto

Le porte CoopLegno sono diventate parte del "Made in Italy" nel design di interni.

CoopLegno ha sviluppato un prodotto industriale di qualità, coniugando la bellezza con la praticità, l'accuratezza con le necessità di una produzione puntuale, veloce ed efficiente. È riuscita a farlo perché conosce perfettamente le porte grazie anche ai suoi inizi artigiani, e ha il polso del mercato in virtù della sua lunga esperienza.

L'unione di questi due saperi permette all'azienda di recepire le novità senza creare scosse nella produzione, di seguire i trend senza perdere di vista l'efficienza.

Solo così è possibile, rispettando i criteri di qualità interna, fornire un prodotto che soddisfi le diverse attese dei clienti.

la certificazione



CoopLegno ha ottenuto, nel dicembre 2006, prima azienda del settore in Italia, la certificazione del proprio sistema di gestione in modo integrato per Qualità, Ambiente e Sicurezza.

Le norme internazionali ISO 9001 per la Qualità, OHSAS 18001 per la Sicurezza, ISO 14001 per l'Ambiente, permettono di gestire responsabilmente, nell'ottica del miglioramento continuo, due aree fortemente presidiate dalle leggi (Sicurezza e Ambiente), integrandole con il sistema di qualità globale, certificato in CoopLegno fin dal 1995.

i materiali

Le porte CoopLegno vengono realizzate attraverso un avanzato processo industriale che prevede lavorazione ed assemblaggio di materie prime ad alta affidabilità.

Dotate di "un'anima" in legno leggera e stabile, le porte si arricchiscono con l'utilizzo di rivestimenti creativi, ricchi, colorati.

Alla vasta scelta di finiture legnose e di laccature colorate si aggiungono, oggi, i **rivestimenti tecnici in laminato**, materiale di grande attualità e dalle prestazioni elevate. Il percorso CoopLegno, ancora una volta, passa attraverso una selezione accurata dei laminati proposti oggi dal mercato per giungere al traguardo di sempre: arricchire la propria gamma di prodotti attuali, affidabili, competitivi.





modelli

Altair

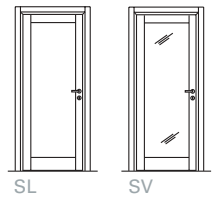

Naos

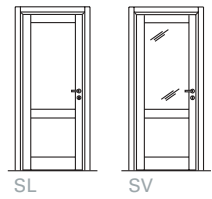

Mizar



Adara



Rigel



Merak



finiture

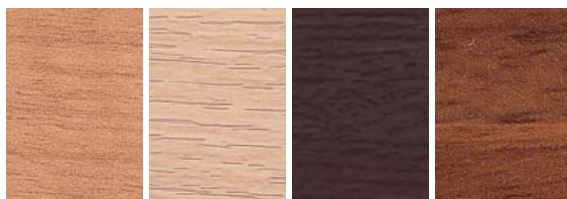

noce
biondo

rovere
sbiancato

wengè

noce
nazionale

collezione
Cosmo



collezione
Cosmo

Altair

finiture

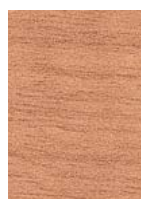

noce
biondo



rovere
sbiancato



wengè



noce
nazionale



Altair SL
wengè

Altair SL e SV
noce biondo



collezione
Cosmo

Naos

finiture

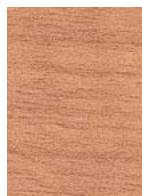

noce
biondo

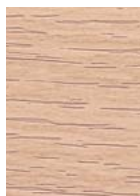

rovere
sbiancato



wengè



noce
nazionale



Naos SV
rovere sbiancato



sopra
Naos SL
rovere sbiancato
e **Naos SL**
noce nazionale

a lato
Mizar SL
noce nazionale

sotto
Mizar SL
rovere sbiancato



collezione
Cosmo

Mizar

finiture

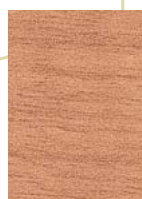

noce
biondo



rovere
sbiancato



wengè



noce
nazionale

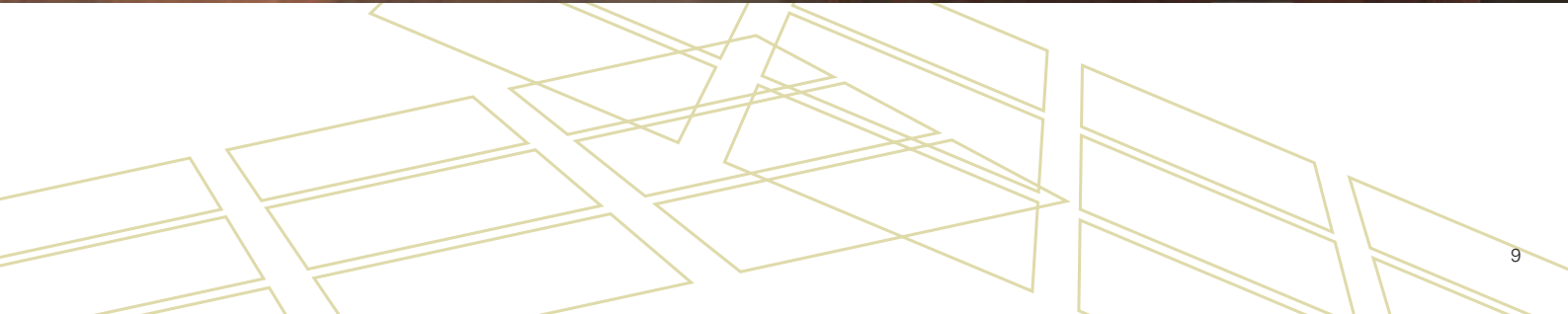



collezione
Cosmo

Adara

finiture

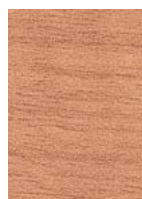

noce
biondo

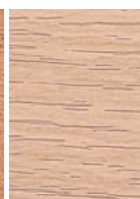

rovere
sbiancato



wengè



noce
nazionale



**Adara SL
wengè,
versione a due ante**



**Adara SL
noce biondo**



collezione
Cosmo

Rigel

finiture

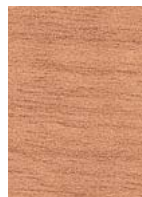

noce
biondo

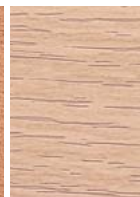

rovere
sbiancato



wengè



noce
nazionale



Rigel SL
noce nazionale

Rigel SL
rovere
sbiancato,
versione
scorrevole
interno parete

a lato
Merak SL
noce biondo

sotto
Merak SL
wengè



collezione
Cosmo

Merak

finiture

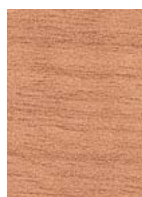

noce
biondo

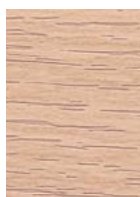

rovere
sbiancato



wengè



noce
nazionale

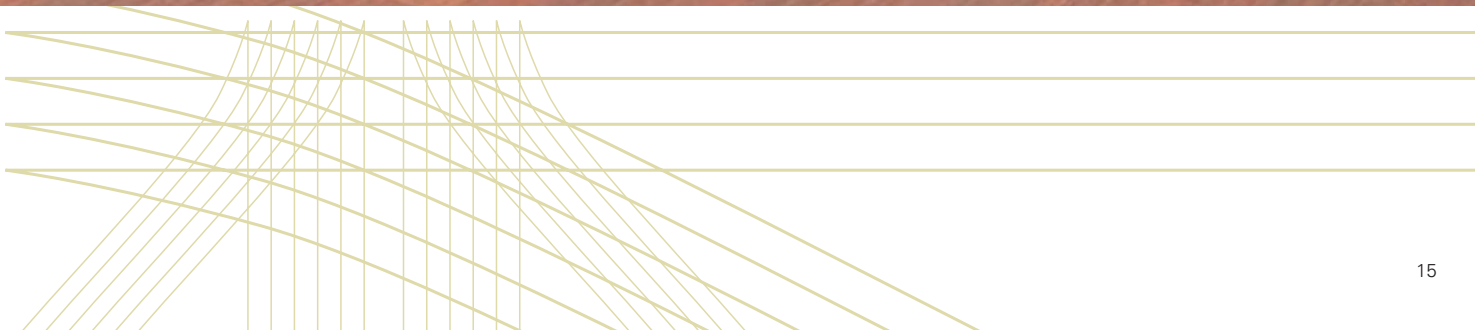



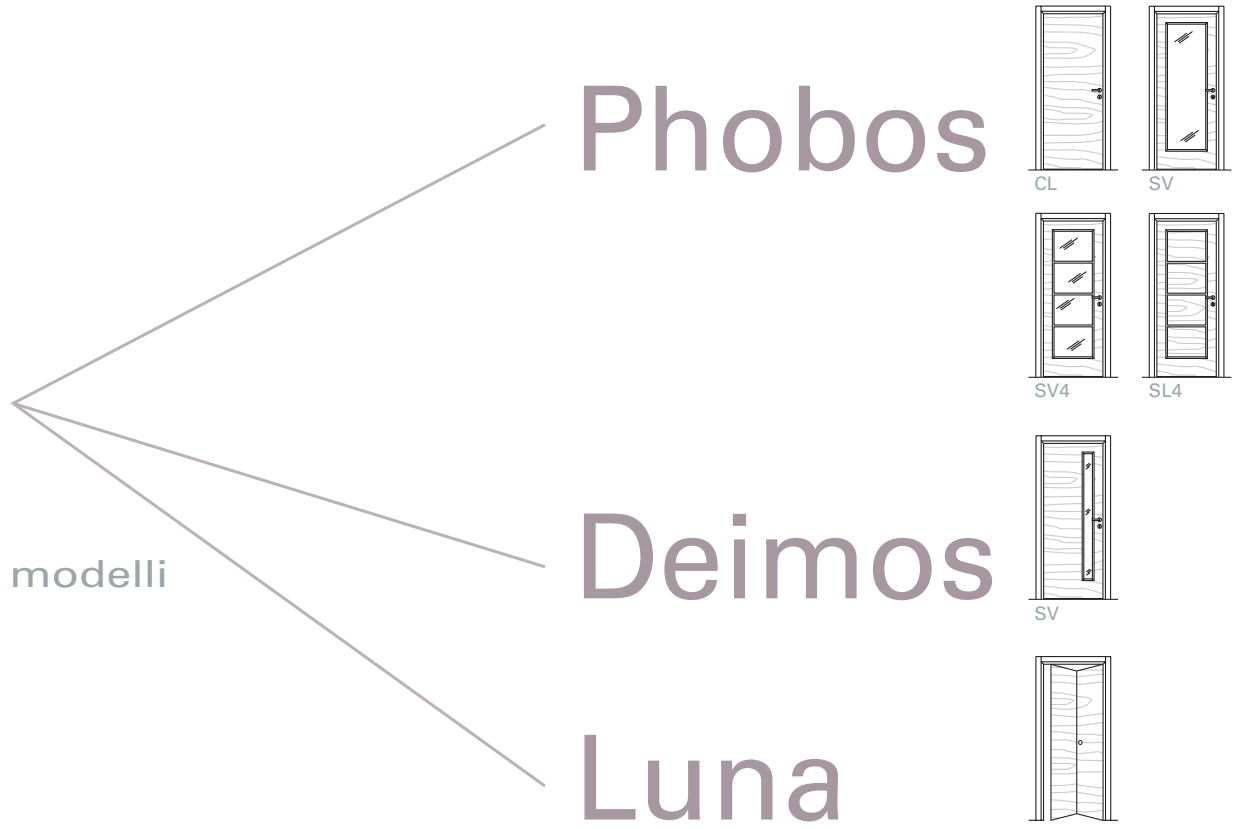

collezione Marte





collezione
Marte

Phobos

finiture



rovere
sbiancato



noce
biondo



noce
nazionale



weng



rovere
ardesia



Phobos SV4 e CL
noce biondo



sopra
Phobos SV
noce biondo

a lato
Phobos SV
noce nazionale



collezione
Marte

Phobos

finiture



rovere
sbiancato

noce
biondo

noce
nazionale

weng

rovere
ardesia





sopra
Phobos CL
rovere sbiancato
e Phobos CL
noce nazionale
con coprifili
tondi

a lato
Phobos CL
weng



collezione
Marte

Phobos

finiture



rovere
sbiancato



noce
biondo



noce
nazionale

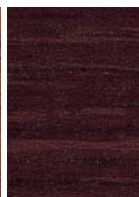

weng



rovere
ardesia

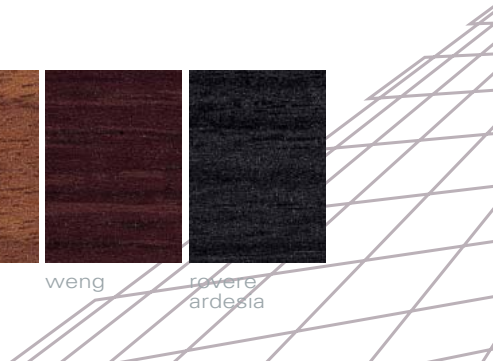



sopra
Phobos CL
rovere ardesia,
versione
a due ante

a lato
Phobos SL4
rovere ardesia

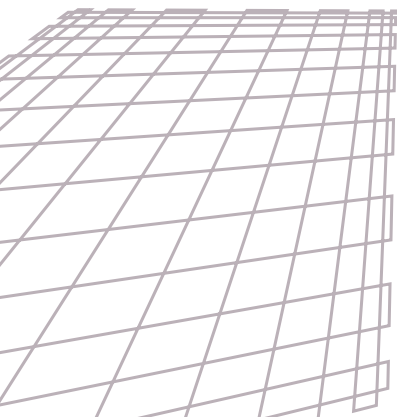



collezione
Marte

Deimos

finiture



rovere
sbiancato



noce
biondo



noce
nazionale



weng



rovere
ardesia

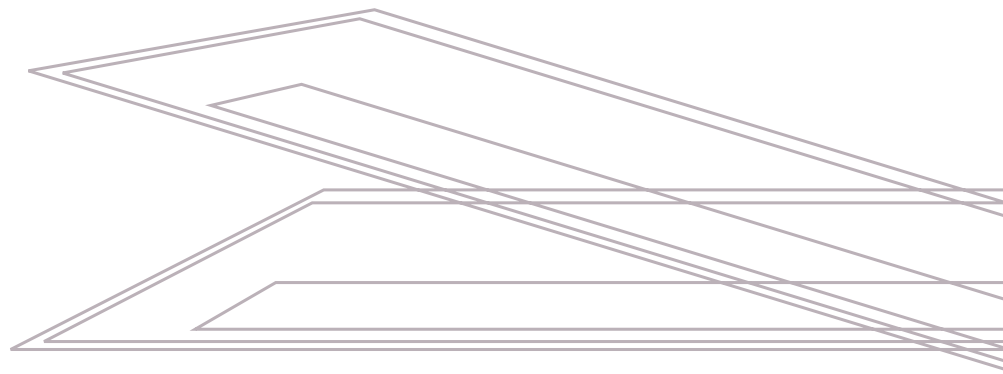

a lato
Deimos SV
rovere ardesia

sotto
Deimos SV
rovere sbiancato,
versione scorrevole
interno parete
e Deimos SV
noce nazionale

sotto
Deimos SV
noce biondo
e Deimos SV
weng





collezione
Marte

Luna

finiture



rovere
sbiancato



noce
biondo



noce
nazionale



weng



rovere
ardesia

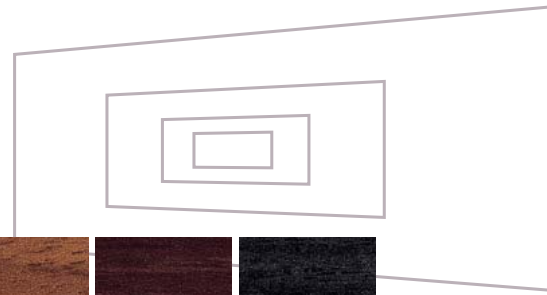

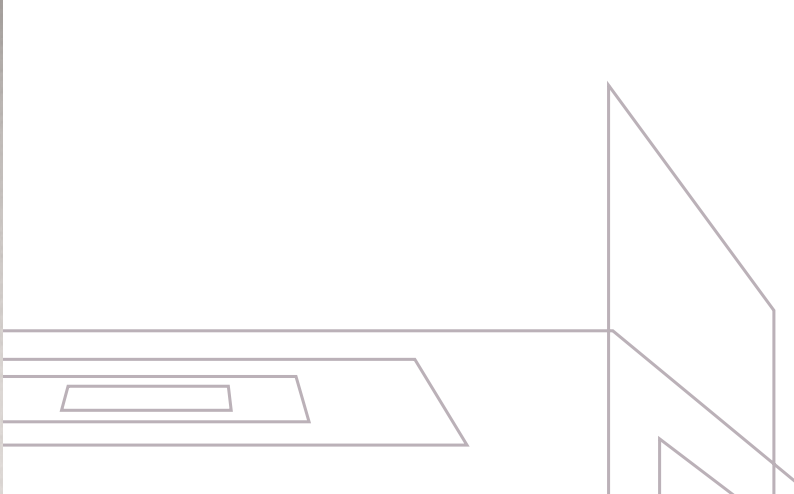

a lato
Luna
noce nazionale

sotto
Luna
rovere ardesia

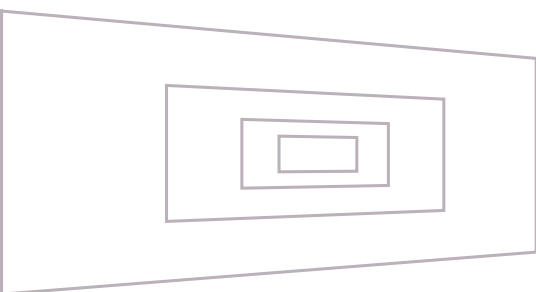

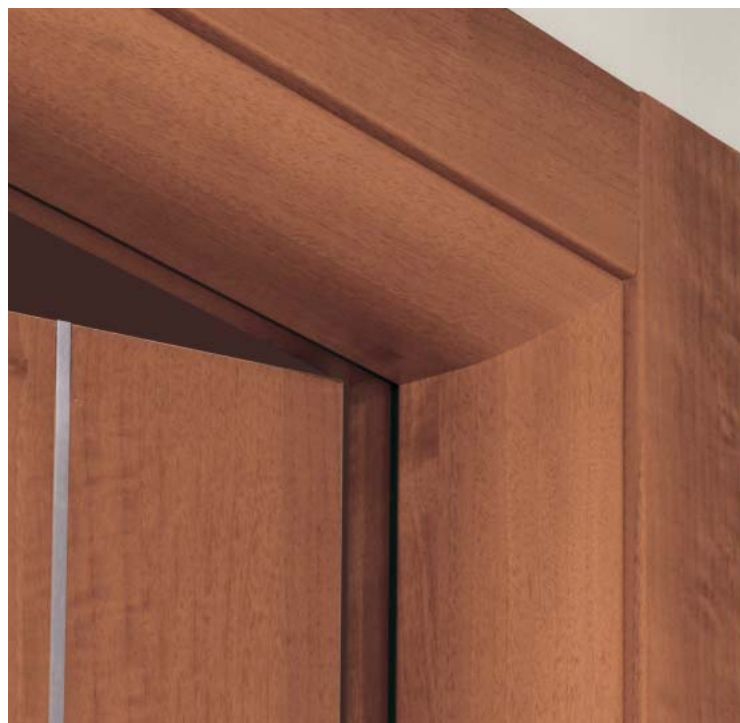
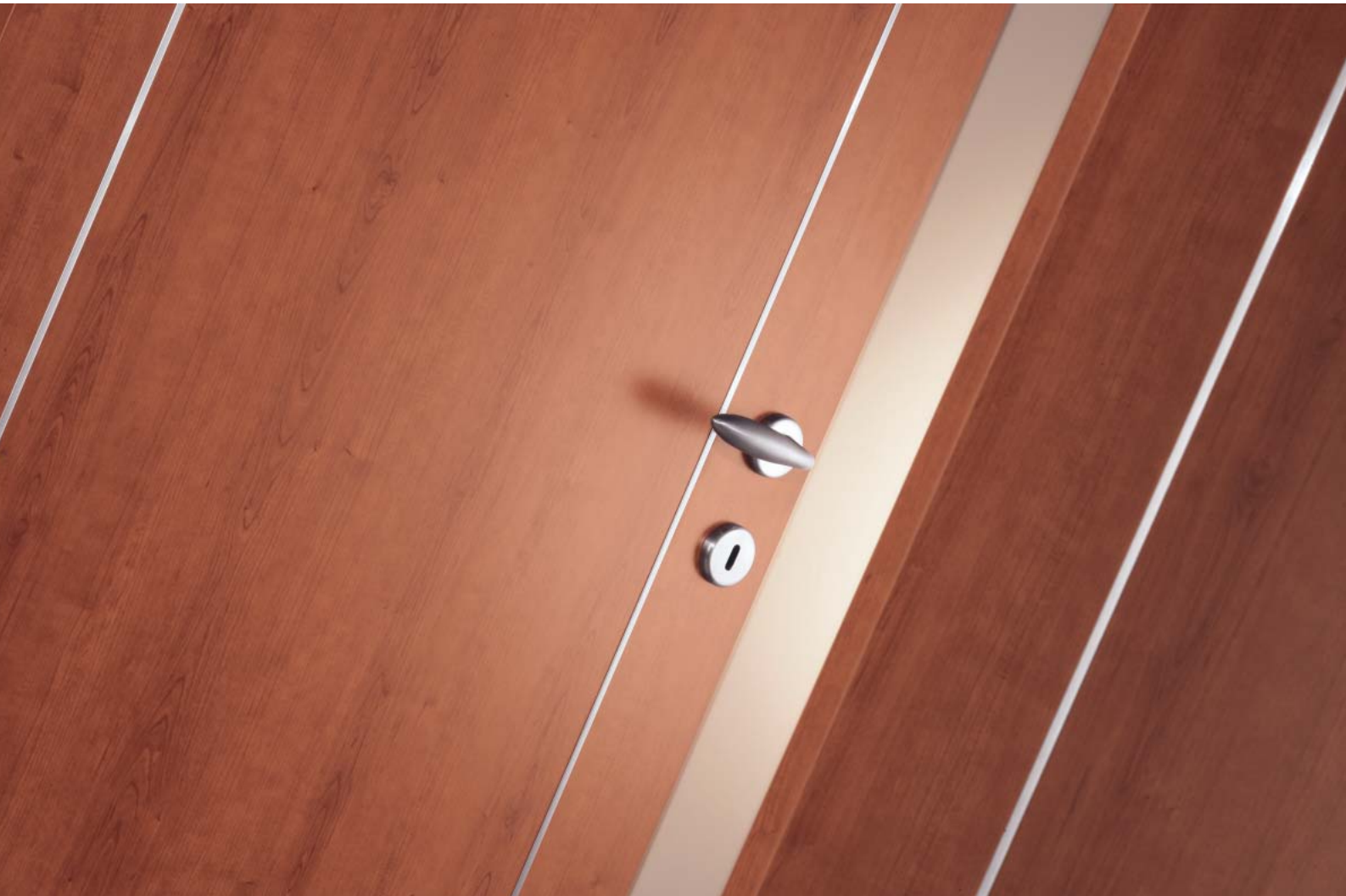

modelli

Rea



Dione

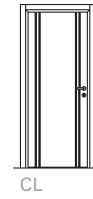

Febe



Teti



finiture

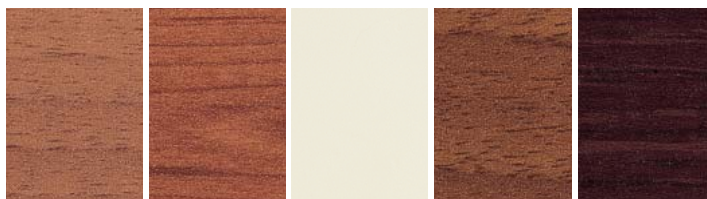

noce
biondo

ciliegio

bianco

noce
nazionale

wengè

collezione
Saturno





collezione
Saturno

Rea

finiture



noce
biondo



ciliegio

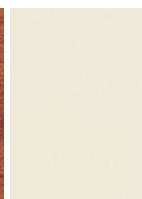

bianco

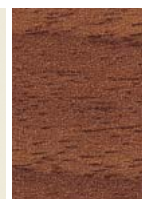

noce
nazionale



wengè



**Rea CL
ciliegio,
versione a due ante**



**Rea CL
noce biondo**

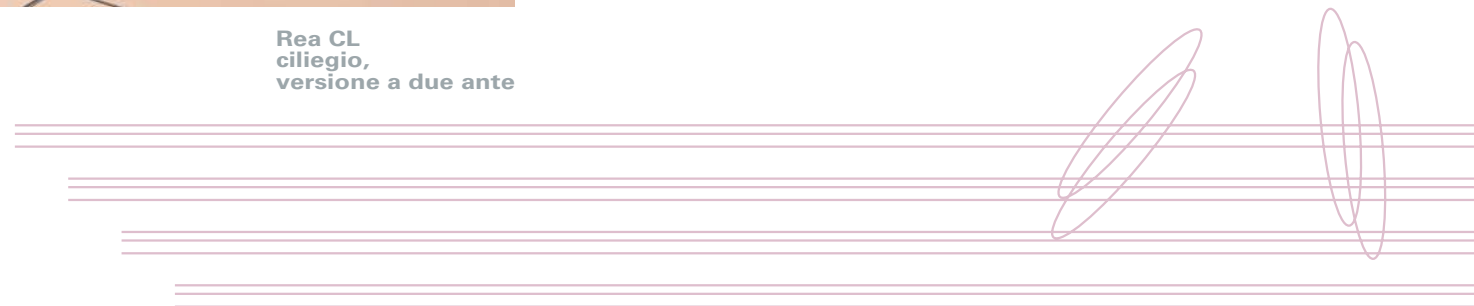

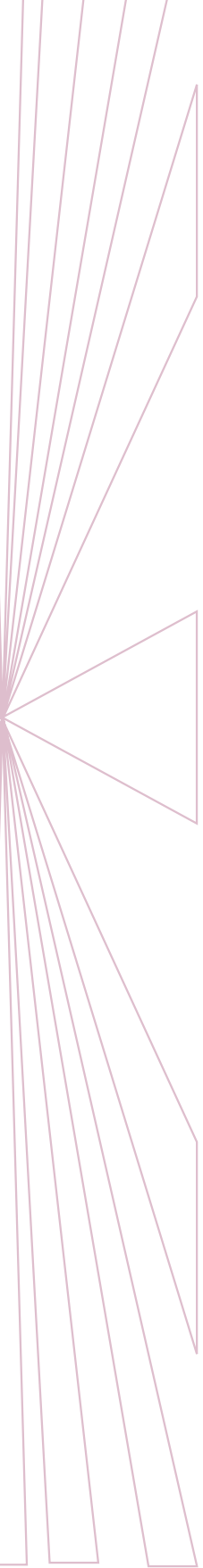

collezione
Saturno

Dione

finiture



noce
biondo



ciliegio



bianco

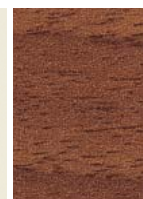

noce
nazionale



wengè



Dione CL
bianco



sopra
Dione CL
noce biondo
e Dione CL
noce nazionale,
versione
scorrevole
interno parete

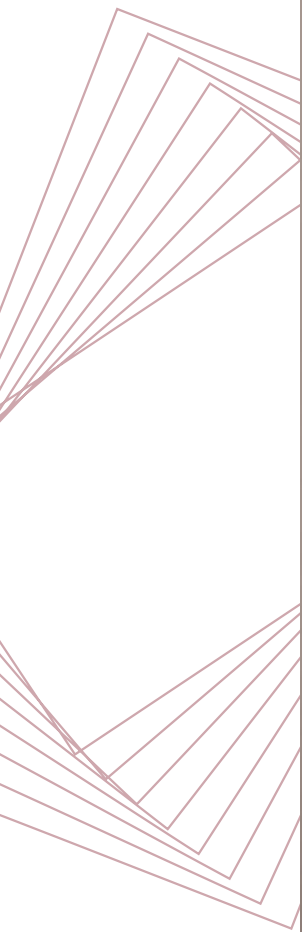

collezione
Saturno

Febe

finiture

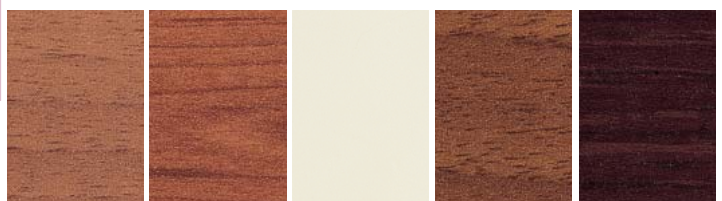

noce
biondo

ciliegio

bianco

noce
nazionale

wengè



a lato
Febe CL
noce nazionale

sotto
Febe CL
noce biondo

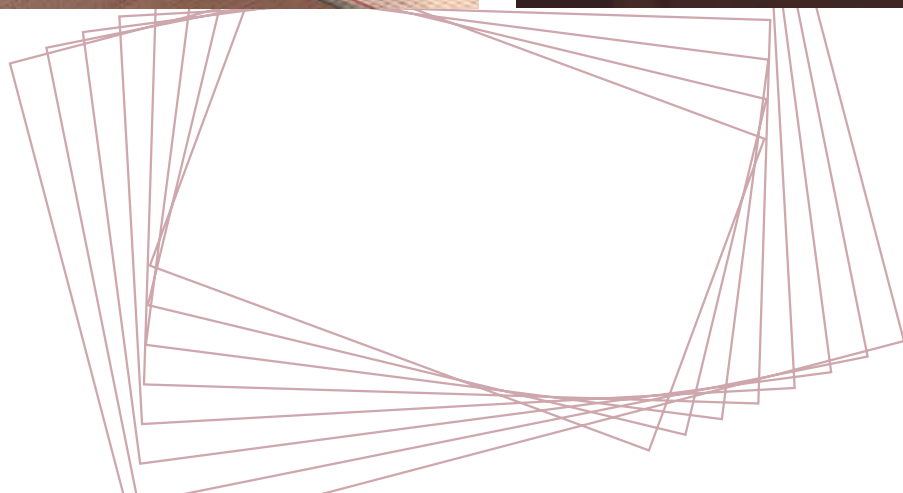

a lato
Teti CL
noce biondo

sotto
Teti CL
wengè



collezione
Saturno

Teti

finiture



noce
biondo

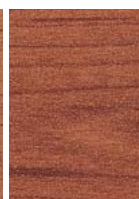

ciliegio

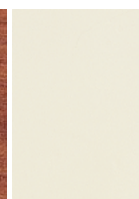

bianco

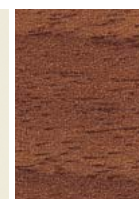

noce
nazionale



wengè



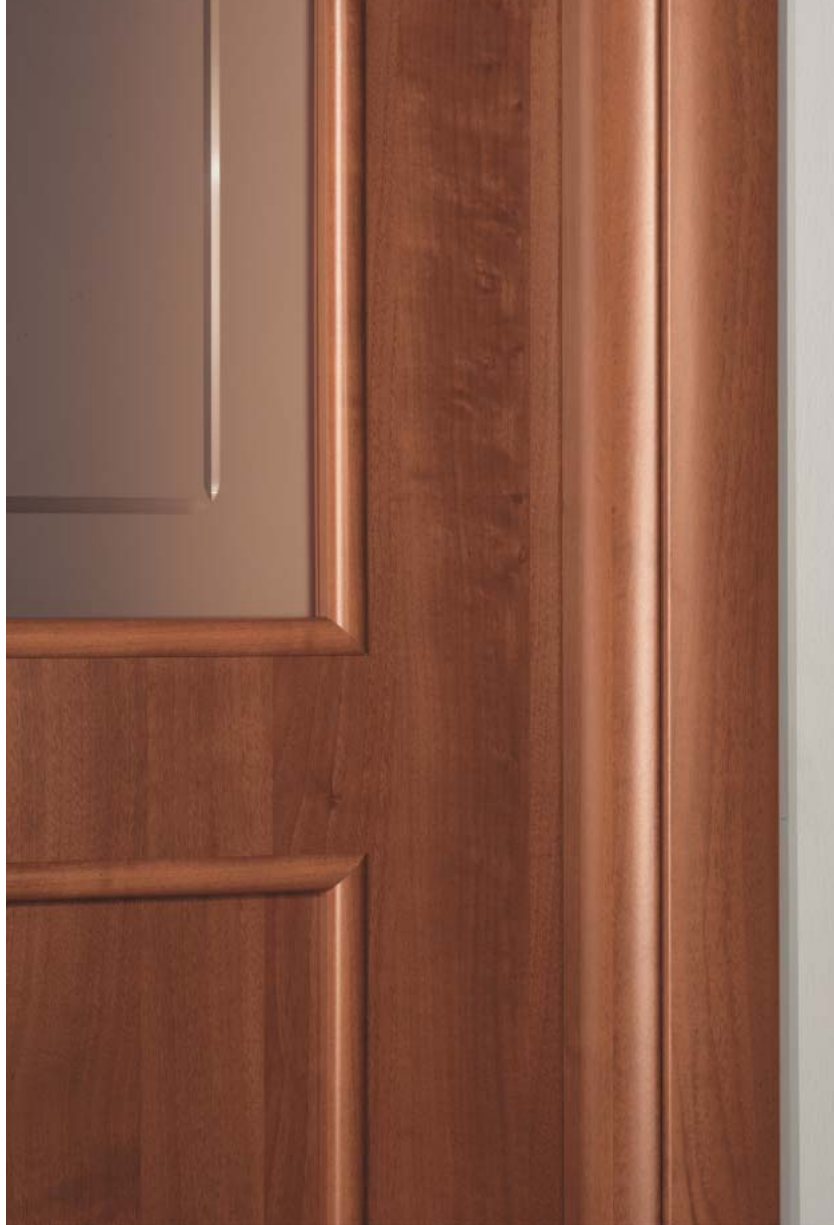
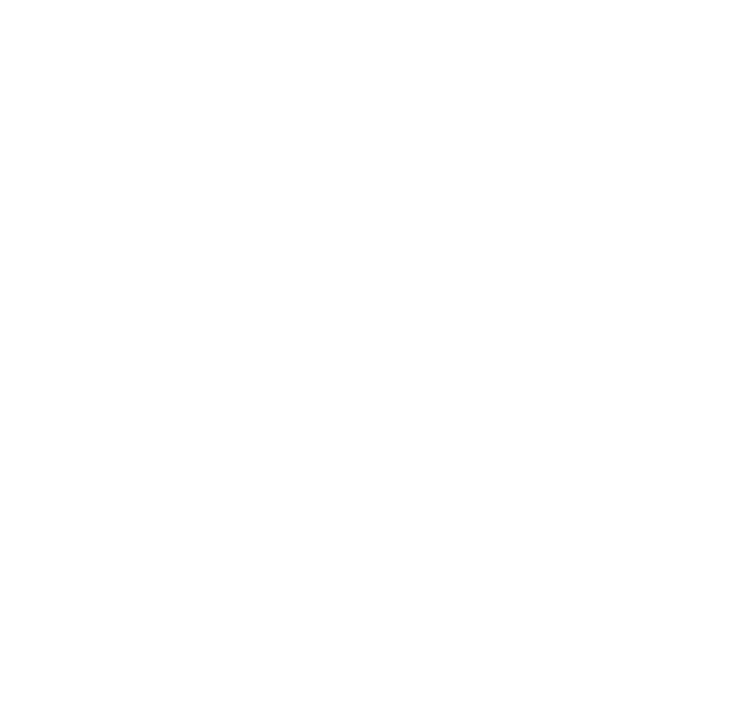

Ariel

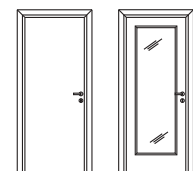

CL

SV

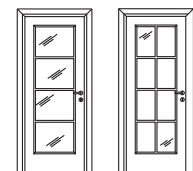

SV4

SI

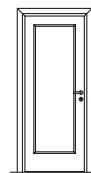

SL

Titania

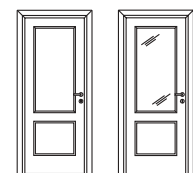

SL

SV



SI

Oberon

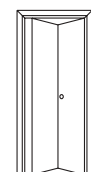

modelli

finiture

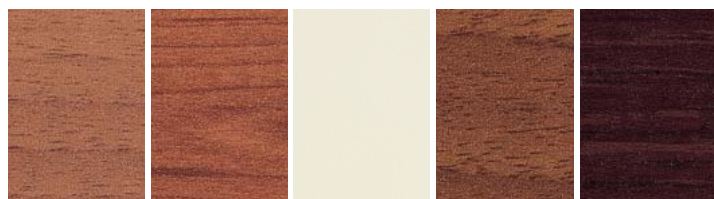

noce
biondo

ciliegio

bianco

noce
nazionale

wengè

collezione Urano

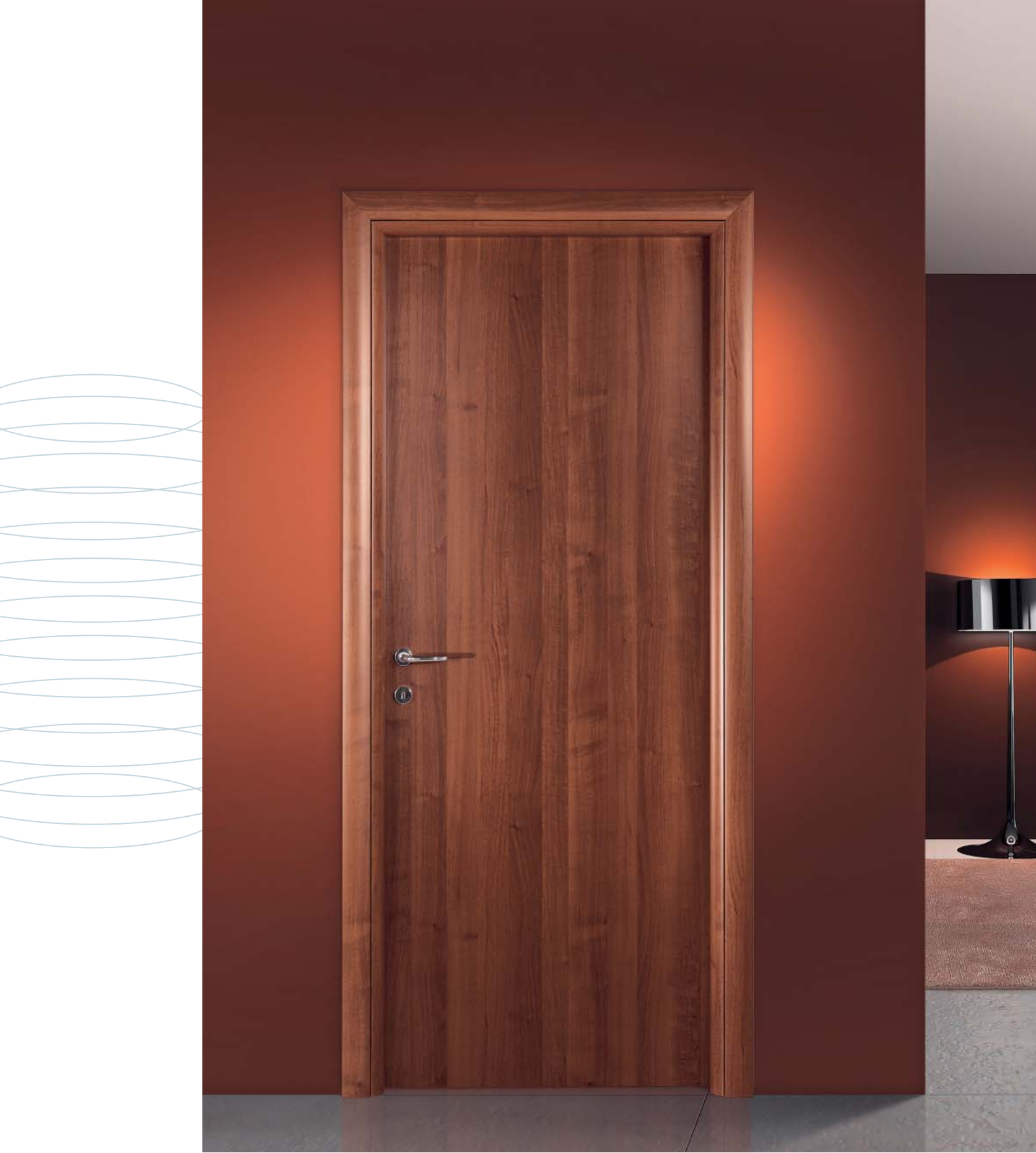

collezione
Urano

Ariel

finiture



noce
biondo



ciliegio

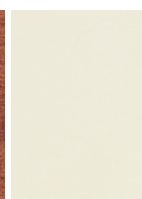

bianco

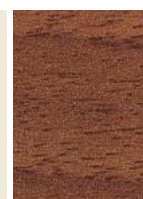

noce
nazionale



wengè



Ariel CL
noce nazionale

in alto
Ariel CL
noce biondo,
bianco, ciliegio
e Ariel CL
wengè
con coprifili piatti

a lato
Ariel CL
noce biondo,
versione
scorrevole
interno parete



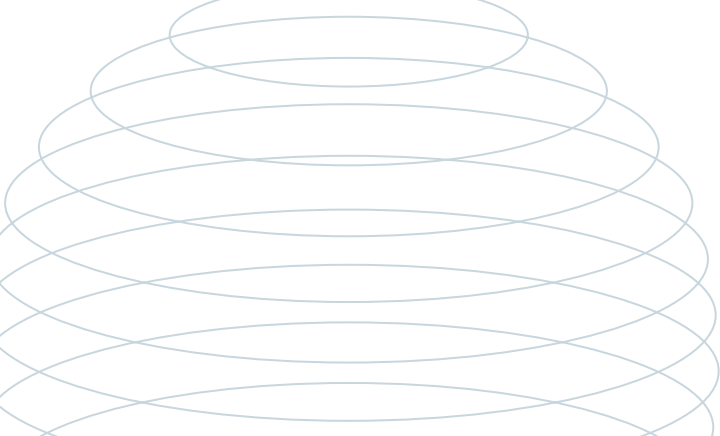

Ariel SI
bianco



collezione
Urano

Ariel

finiture

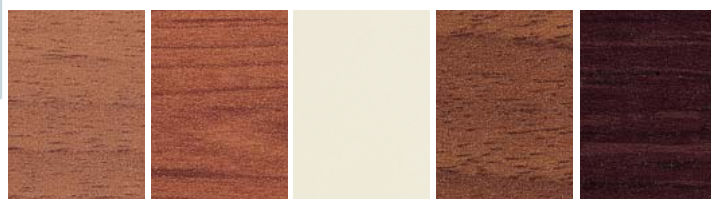

noce
biondo

ciliegio

bianco

noce
nazionale

wengè

Ariel SV
ciliegio

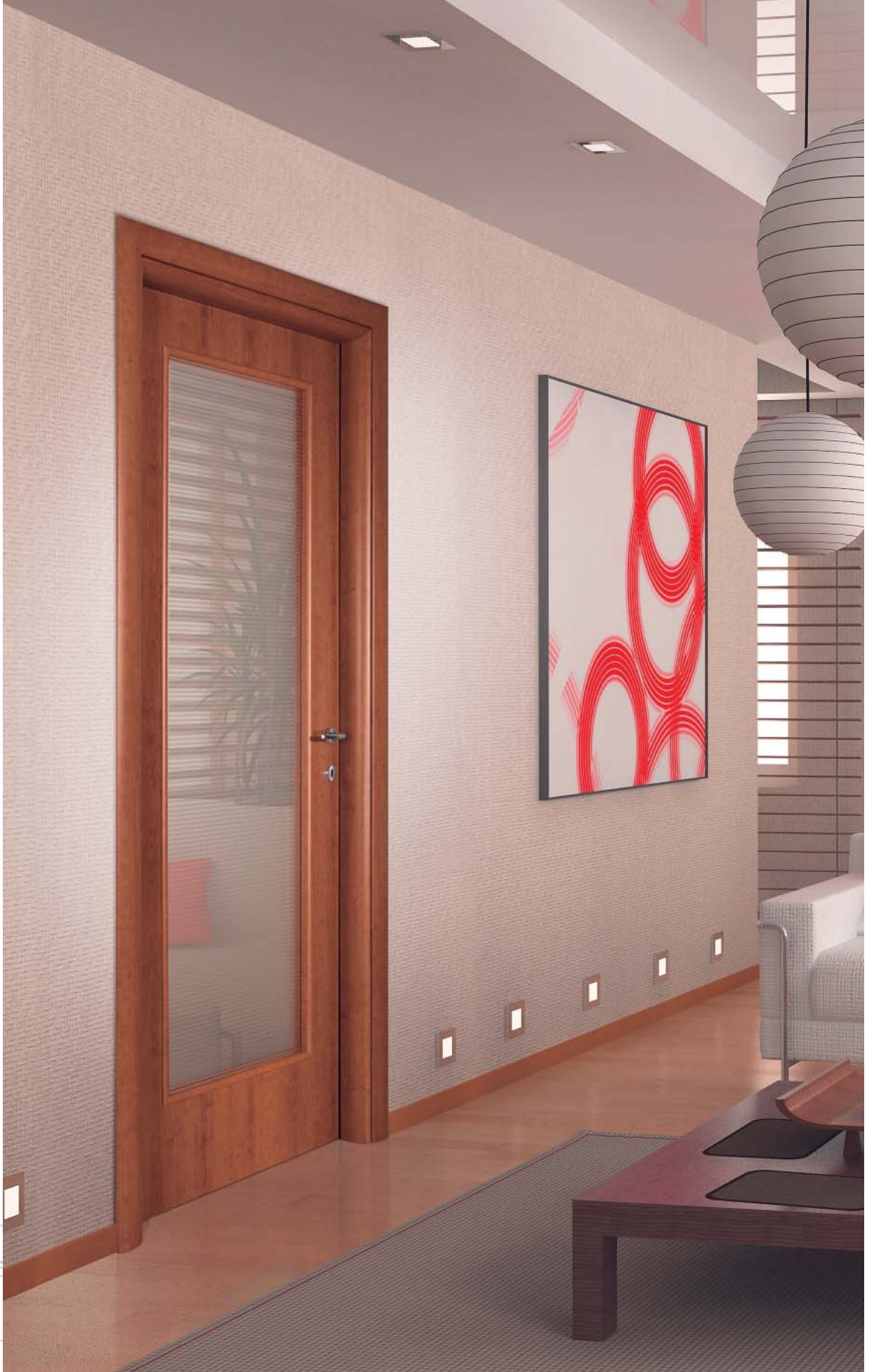



collezione
Urano

Ariel

finiture



noce
biondo



ciliegio



bianco



noce
nazionale

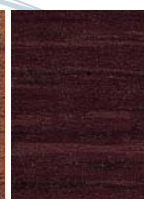

wengè



Ariel SL
wengè



sopra
Ariel SV4
wengè,
versione
a due ante

a lato
Ariel SV4
noce biondo

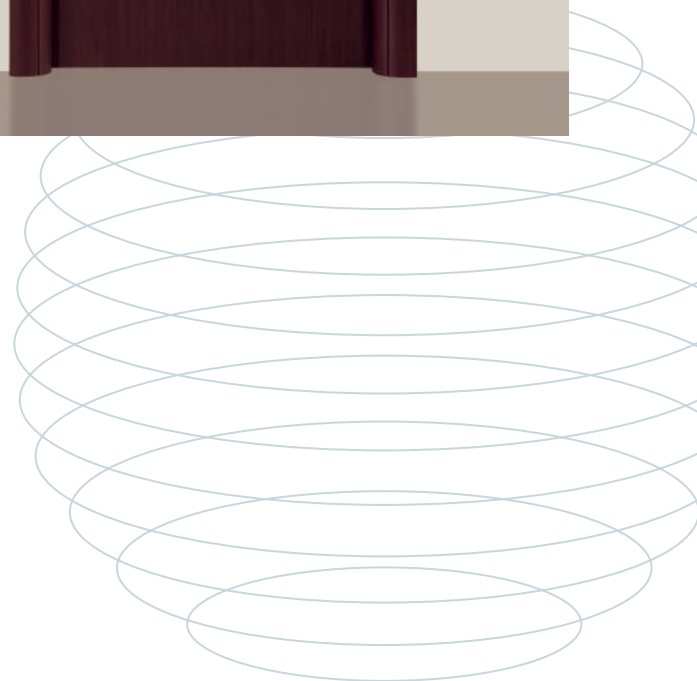



collezione
Urano

Titania

finiture

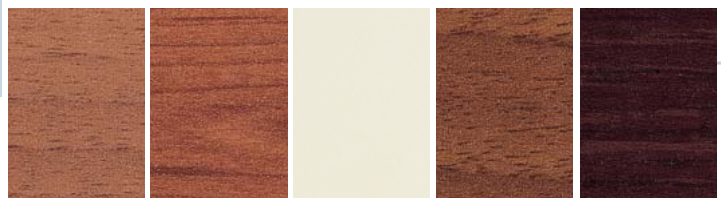

noce
biondo

ciliegio

bianco

noce
nazionale

wengè



sopra
Titania SL
noce biondo

a lato
Titania SV
noce nazionale
e Titania SI
wengè

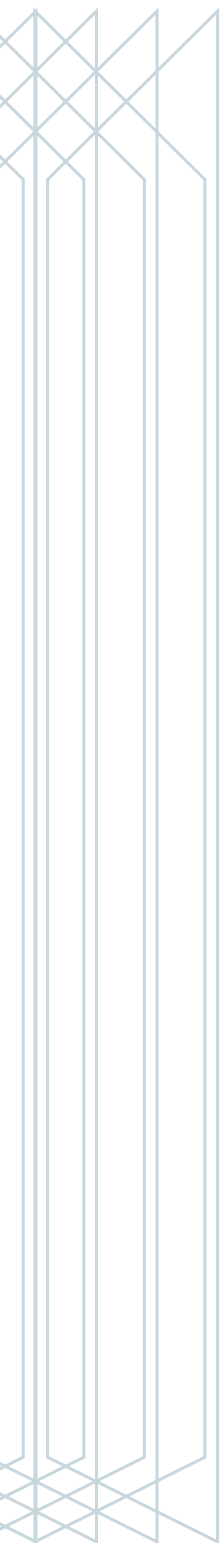

Oberon
noce biondo

collezione
Urano

Oberon

finiture



noce
biondo



ciliegio



bianco



noce
nazionale



wengè



telai di
passaggio

per tutte
le collezioni

con coprifili coordinati
e in tutte le finiture



telaio
standard
collezione
Cosmo



telaio
standard
collezioni
**Marte e
Saturno**



telaio
standard
collezione
Urano

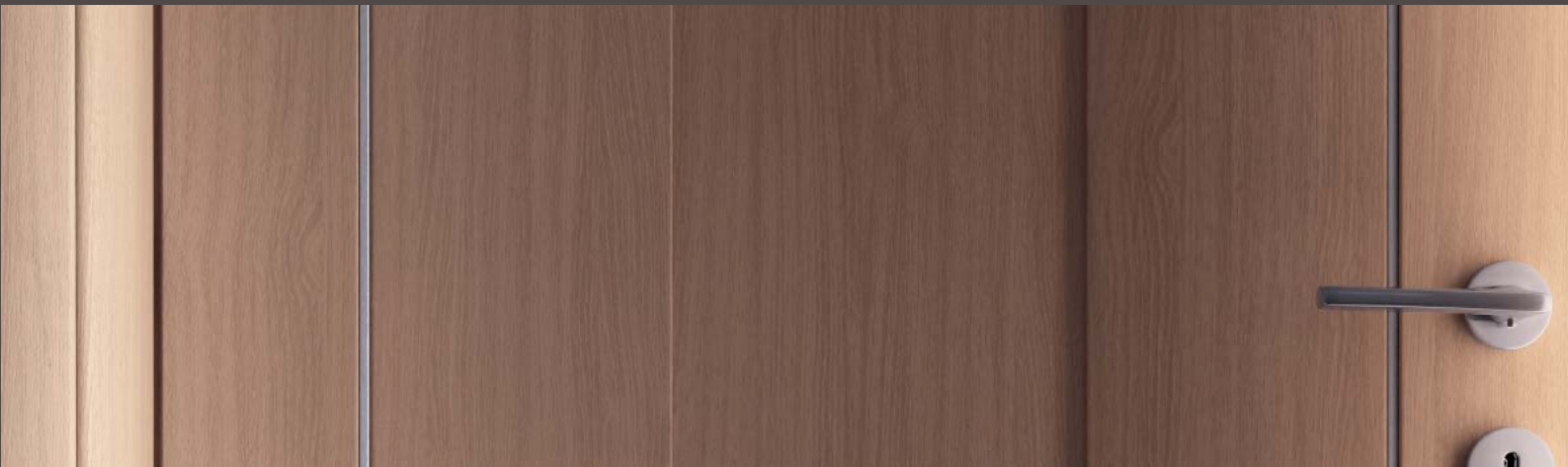

universo CoopLegno

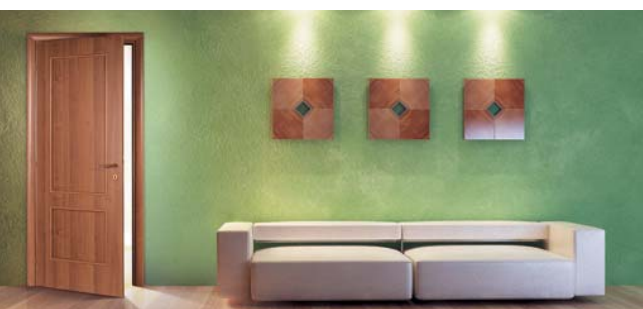
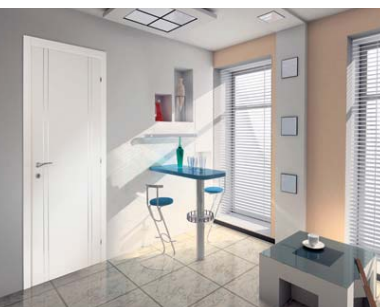
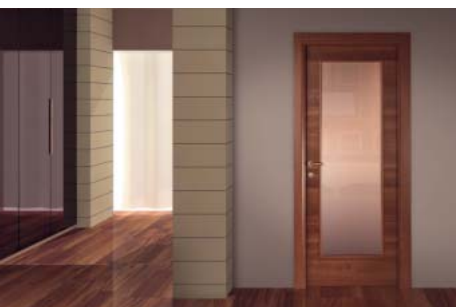

Le fotografie, i disegni, le illustrazioni ed i colori hanno valore puramente indicativo. CoopLegno si riserva il diritto di apportare, senza preavviso, in qualsiasi momento e per qualsiasi motivo tutte le modifiche che riterrà utili.

Tutti i diritti riservati.

direzione del progetto
William Longhi/CoopLegno
coordinamento generale
Giuliana Cavani/CoopLegno
ideazione e progetto grafico
Consenso comunicazione
fotografie
Autori associati
copyright immagini 3D artisti
vari 2007 concesse in licenza
da Shutterstock Inc.
elaborazioni **Lucio Aloisi**
stampa
Nuovografica
copyright 2008 CoopLegno
edizione 2008



COOPLEGNO



COOP LEGNO società cooperativa
I-41014 Castelvetro di Modena (MO)
via Sant'Eusebio, 4/G
telefono +39 059 702712
telefax +39 059 702254

cooplegno@cooplegno.it
export@cooplegno.it
www.cooplegno.it